



modello:
model:

**STAR MEDIUM
ASIMMETRICO**

codice:
code:

6712

design:

UT Egoluce

anno - year:

2022

tipologia:
typology:

**faretto mini trim da incasso
mini trim recessed spotlight**

materiali:

**corpo in alluminio, riflettore interno
in policarbonato metallizzato**

materials:

**structure in aluminum, internal
reflector in metallized polycarbonate**

luce:

diretta

light:..

direct

sorgente luminosa: light
source:

/W	LED 8,91W 17,8V 500mA	1353lm	4000K
/WW	LED 8,91W 17,8V 500mA	1303lm	3000K
/XW	LED 8,91W 17,8V 500mA	1244lm	2700K

life

> 50.000 h

step MacAdam

3

Indice di Resa Cromatica:
Color Rendering Index:

>80

**CRI>90 su richiesta
CRI>90 on request**

grado IP - IP grade:

40

peso netto - net weight:

0,20 Kg

finiture - finishes:

.01	bianco	.01	white
.02	nero	.02	black
.25	dorato satinato	.25	golden satin
.32	nickel satinato	.32	satin nickel

marcatura:

CE

marking:

simboli costruttivi:

F III IP40  

symbols:

Dimensioni - Dimensions

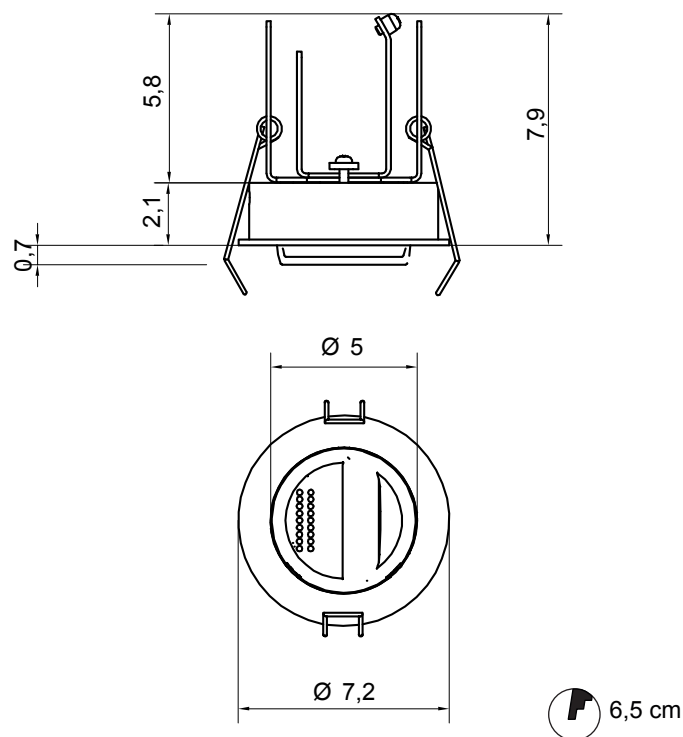

SOLO COLLEGAMENTO IN SERIE - ONLY SERIAL CONNECTION

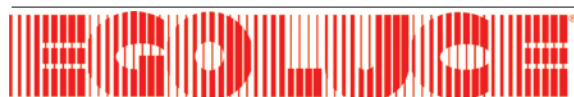

EGOLUCE s.r.l., via I. Newton 12 - 20016 Pero - Milano
telefono +39 02 339586.1 - fax. +39 02 3535112
e-mail: info@egoluce.com - http://www.egoluce.com

LED DRIVERS in corrente continua
LED DRIVERS constant current
0127

LED driver
 IN: 100 - 240V
 OUT: 500 mA
 1 COB LED

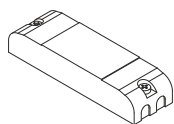

11,6 x 3,4 x 2 cm 4 cm

0147/COB

LED driver
 IN: 220 - 240V
 OUT: 500 mA
 1-2 COB LED

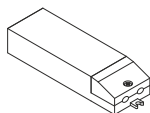

12,5 x 3,8 x 2,4 cm 4,2 cm

0149/COB

LED driver
 IN: 220 - 240V
 OUT: 500 mA
 1 COB LED

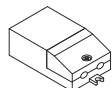

7,6 x 3,9 x 2,2 cm 4,2 cm

0169/50**Multipower LED driver**

IN: 220 - 240V
 OUT: 500mA
 1-3 COB LED

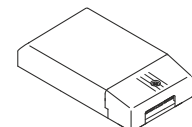

13 x 7,5 x 3 cm 8,5 cm

DRIVERS DIMMERABILI in corrente continua
DIMMABLE LED DRIVERS constant current
0129 Dimmer LED
Multipower dimmable driver

IN: 110 - 240V
 OUT: 500 mA
 1-2 COB LED

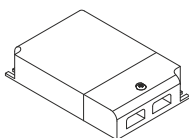

10,5 x 7 x 2,2 cm 7,2 cm SELV

0129/DALI Dimmer LED**Multipower dimmable driver**

IN: 110 - 240V
 OUT: 500 mA
 1-2 COB LED

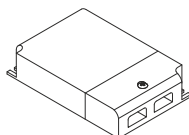

10,5 x 7 x 2,2 cm 7,2 cm SELV

0141/DALI**LED driver**

IN: 110 - 240V
 OUT: 500 mA
 1-2 COB LED

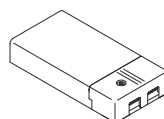

11,1 x 5,2 x 2,5 cm 5,5 cm

0141/DIM**LED driver**

IN: 110 - 240V
 OUT: 500 mA,
 1-2 COB LED

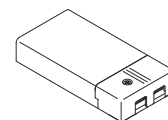

Versione PUSH non sincronizzabile - PUSH version not synchronizable

11,1 x 5,2 x 2,5 cm 5,5 cm

0145 Dimmer LED Maxi**Multipower dimmable driver**

IN: 110 - 240V
 OUT: 500 mA
 1-3 COB LED

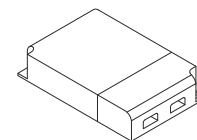

12,3 x 8 x 2,2 cm 8,4 cm SELV

0145/DALI Dimmer LED Maxi**Multipower dimmable driver**

IN: 110 - 240V
 OUT: 500 mA
 1-3 COB LED

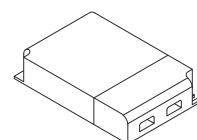

12,3 x 8 x 2,2 cm
 8,4 cm SELV

0133

Cavo di sincronizzazione per dimmer LED

Synchronization cable for dimmer LED

(art. 0129 - art. 0129/DALI - art. 0145 - art. 0145/DALI)



L 150 cm

0726/DIM**LED dimmer**

TAGLIO DI FASE (IGBT-TRIAC, TRAILING EDGE-LEADING EDGE)

PHASE CUT-OFF (IGBT-TRIAC, TRAILING EDGE-LEADING EDGE)

IN: 220 - 240V
 OUT: 24V - 20W
 500 mA
 1-2 COB LED

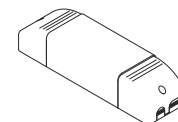

16,5 x 4,5 x 3,5 cm 5,6 cm IGBT-TRIAC SELV

0734/DIM**LED dimmer**

Alimentatori elettronici dimmerabili (IGBT-TRIAC) in corrente continua
 Direct current dimmable (TRAILING EDGE-LEADING EDGE) electronic drivers

IN: 220 - 240V
 OUT: 500 mA
 1 COB LED

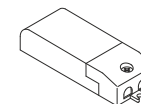

8,7 x 3,8 x 2,1 cm 4,2 cm IGBT-TRIAC SELV

UNITA' DI EMERGENZA LED
LED EMERGENCY UNIT
0115/EM**LED Emergency Unit**

Kit Inverter + Battery + LED indicator



15,5 x 5,2 x 2,5 cm 80 cm 13,5 x 4,5 x 2,3 cm

